

Global provider of medical devices,  
plastics solutions and pharmaceutical systems

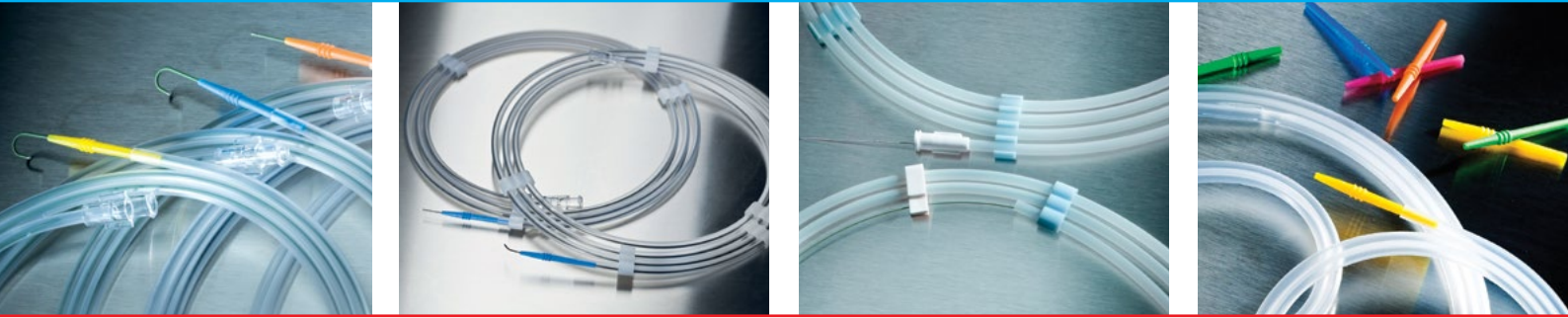

## Guide Wires

- 3 A Brief Guide Wire Introduction
- 4 Accoat™ Guide Wire – Seldinger
- 5 Accoat™ Guide Wire – Double ended Seldinger
- 6 Accoat™ Guide Wire – Movable
- 7 Accoat™ Standard Guide Wire – Lunderquist PTC
- 8 Accoat™ Standard Guide Wire – Schüller PTC
- 9 Poseidon™ Hydrophilic Nitinol Guide Wire
- 10 CHAMPION™ PTCA Guide Wire – For Cardiology use (CAR)
- 11 CHAMPION™ PTCA Guide Wire – Stiff tip for highly stenosed lesions (CTO)
- 12 Coating of Medical Devices and Components
- 13 Accessories and packing material
- 14 Quality and Regulatory Affairs

---

SP Medical develops, manufactures and distributes disposable items such as Guide Wires to the hospital sector focusing on minimally invasive procedures in the field of radiology, urology, gastro and cardiology.

At our state-of-the-art facilities in Denmark and Poland, we manufacture components, medical

devices, single-use devices, and we apply function-enhancing coatings to a number of products.

SP Medical is a company in SP Group A/S, an international plastics group headquartered in Denmark. SP Group is listed on NASDAQ OMX Copenhagen.

---

## A Brief Guide Wire Introduction

### Guide Wires and coating

SP Medical is a Danish company with more than 30 years' experience and know-how in the field of development, manufacturing and sales of guide wires for the medical industry. Over the past 40 years, we have built up our know-how of PTFE coated semi-products and medical devices for leading suppliers of for example guide wires on an OEM basis.

It is SP Medical's goal to offer customers a complete guide wire programme of high

quality and, if required, of special features.

### Vision

SP Medical develops, manufactures and distributes disposable items such as guide wires to the hospital sector focusing on minimally invasive procedures in the field of:

- Angiography use (PTA)
- Cardiology (PTCA)
- Urology use (PTC)
- Gastro- enterology use

Moreover SP Medical contributes to the manufacturing of other

companies' medical devices, primarily by applying coating to improve functionality.

### Policy

SP Medical's high quality product programme is currently being enlarged with customized special articles by means of structured product development of both process and machinery construction.

SP Medical's articles are manufactured in controlled hygienic environment by a trained staff. The manufacturing is performed

with the greatest possible extend of automation to achieve both conform and good quality at competitive prices.

SP Medical A/S develops and manufactures own branded CE marked Guide Wires as well as OEM products.

The articles are sold and marketed either to manufacturers of medical devices or through our international distributor's network.

## Core products and features

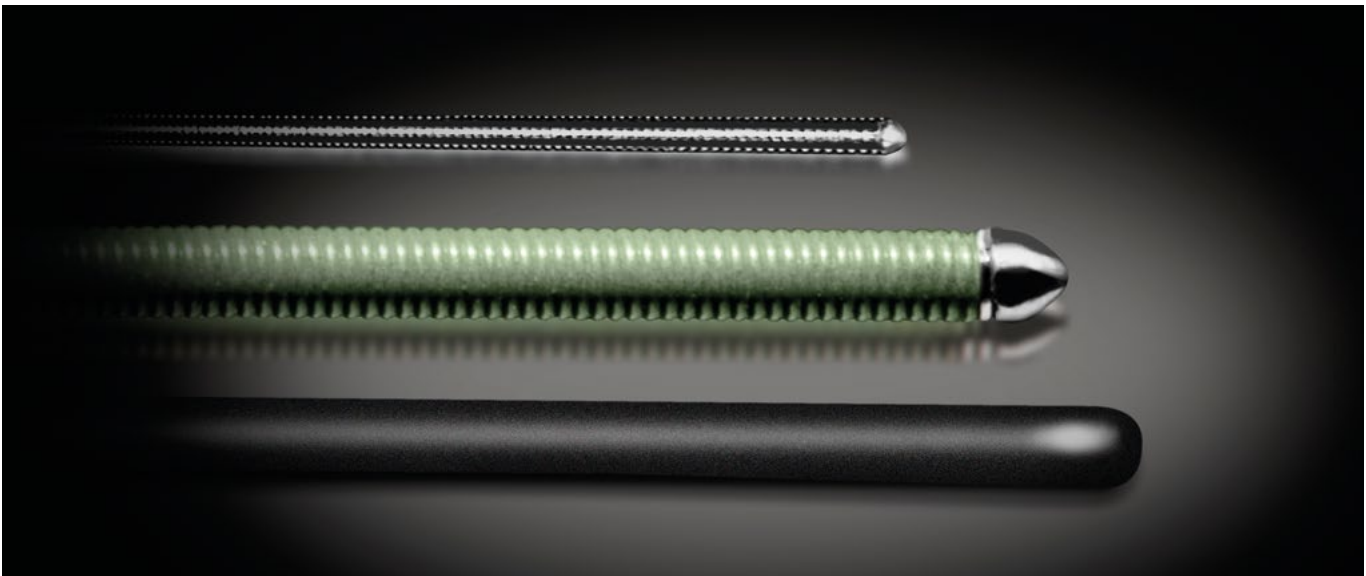

### Champion™ PTCA Guide Wire:

- Platinum Tip for excellent radiopacity.
- One core construction with superior torque ability.
- PTFE coated shaft for smooth surface.
- Various tip coatings for reduced friction.
- For both Cardiology and CTO.

### Accoat™ Guide Wire:

- Complete and functional coating from distal to proximal end.
- Polished and 100% inspected in both ends.
- No possibility for drainage of blood due to special coating method.
- Smooth surface due to homogeneous coating.

### Poseidon™ Hydrophilic Nitinol Guide Wire:

- Excellent radiopacity.
- Reduced friction due to superior hydrophilic surface features.
- Different tip flexibilities.
- Kink-resistant nitinol core.

Accoat™ Guide Wire – Seldinger

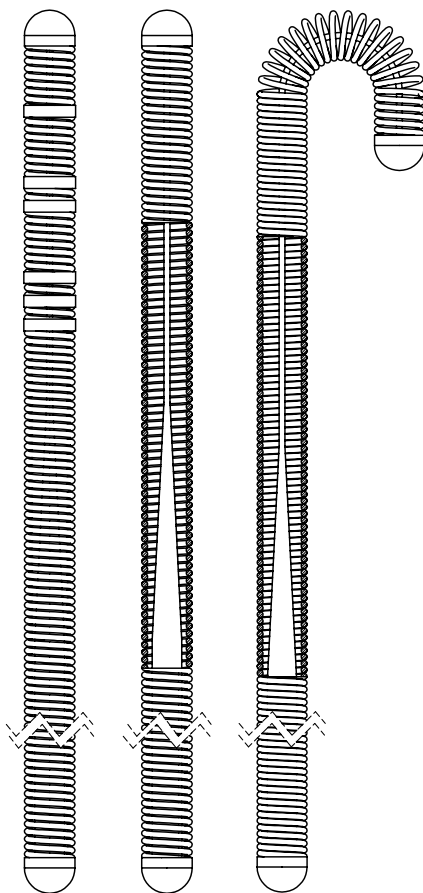
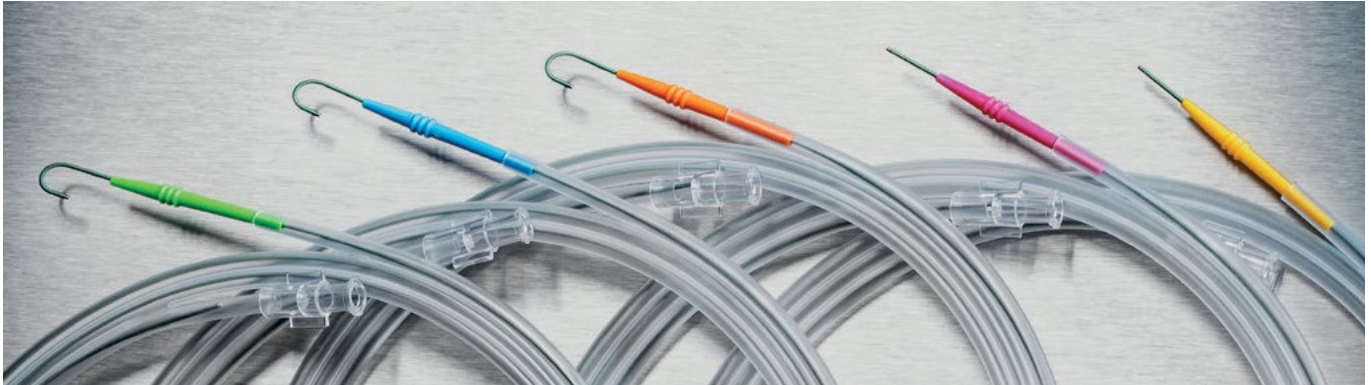

**Dimensions**

- Ø 0.018" / 0,46 mm
- Ø 0.021" / 0,53 mm
- Ø 0.025" / 0,63 mm
- Ø 0.028" / 0,71 mm
- Ø 0.032" / 0,81 mm
- Ø 0.035" / 0,89 mm
- Ø 0.038" / 0,96 mm

**Length**

30 – 450 cm

**Surface**

Stainless steel with or without markers  
PTFE coated

**Distal tip form**

Straight tip  
J-tip radius: 1,5 – 3 – 6 – 15 mm

**Distal flexible length**

Standard 4,5 cm flexible tip

**Shaft stiffness**

Standard  
Stiff  
Extra stiff  
Super stiff  
*(Extra stiff & Super stiff not available  
in dim.: 0.018"; 0.021"; 0.025")*

**Markers**

Uncoated stainless steel  
OEM  
Length 30-150 cm  
1 mm wide surface markers  
10 cm step

**Customised products on request**

**Description of item code**

(H/X/X)-S/Jx-(C)-0xx-L  
*(example: J3-C-035-150)*

<b>H</b>	Stiff Guide Wire
<b>H-X</b>	Extra Stiff Guide Wire
<b>H-X-X</b>	Super Stiff Guide Wire
<b>S</b>	Straight tip
<b>Jx</b>	J-tip radius J1.5 mm J3 mm J6 mm J15 mm
<b>C</b>	PTFE coated
<b>Without C</b>	stainless steel
<b>M</b>	Surface marker
<b>0xx:</b>	Diameter of the guide wire <b>018:</b> 0.018" (0,46 mm) <b>021:</b> 0.021" (0,53 mm) <b>025:</b> 0.025" (0,63 mm) <b>028:</b> 0.028" (0,71 mm) <b>032:</b> 0.032" (0,81 mm) <b>035:</b> 0.035" (0,89 mm) <b>038:</b> 0.038" (0,96 mm)
<b>L:</b>	Length of the guide wire (from 30 – 450 cm)

Accoat™ Guide Wire – Double ended Seldinger

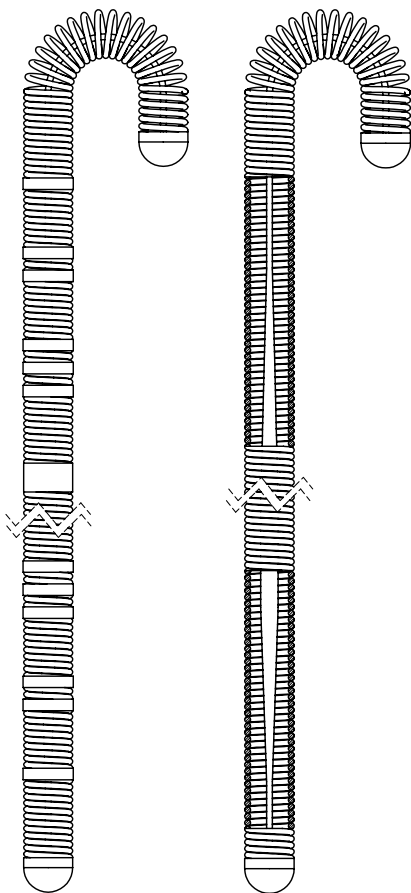

**Dimensions**

- Ø 0.025" / 0,63 mm
- Ø 0.032" / 0,81 mm
- Ø 0.035" / 0,89 mm
- Ø 0.038" / 0,96 mm

**Length**

30 – 450 cm

**Surface**

Stainless steel with or without markers  
PTFE coated

**Tip form**

J-tip radius: 1,5 – 3 – 6 – 15 mm in  
one end and straight tip in the other

**Flexible tip length**

Standard 5 cm flexible tip

**Shaft stiffness**

Standard  
Stiff

**Markers**

Uncoated stainless steel  
OEM  
Length 30-150 cm  
1 mm wide surface markers  
10 cm step

**Customised products on request**

**Description of item code**

(H)-D-S-Jx-(C)-0xx-L  
(example: D-S-J3-C-035-150)

<b>H</b>	Stiff Guide Wire
<b>D</b>	Double ended (flexible tip in both ends)
<b>S</b>	Straight tip (one end)
<b>Jx</b>	J-tip radius (the other end) J1.5 mm J3 mm J6 mm J15 mm
<b>C</b>	PTFE coated
<b>Without C</b>	stainless steel
<b>M</b>	Surface marker
<b>0xx:</b>	Diameter of the guide wire <b>025:</b> 0.025" (0,63 mm) <b>032:</b> 0.032" (0,81 mm) <b>035:</b> 0.035" (0,89 mm) <b>038:</b> 0.038" (0,96 mm)
<b>L:</b>	Length of the guide wire (from 30 – 450 cm)

Accoat™ Guide Wire – Movable

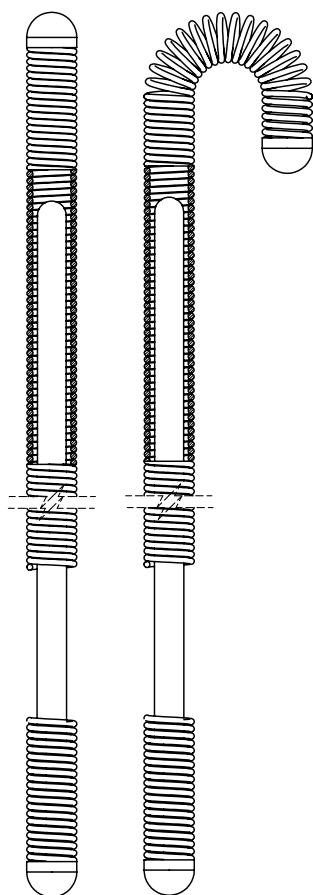
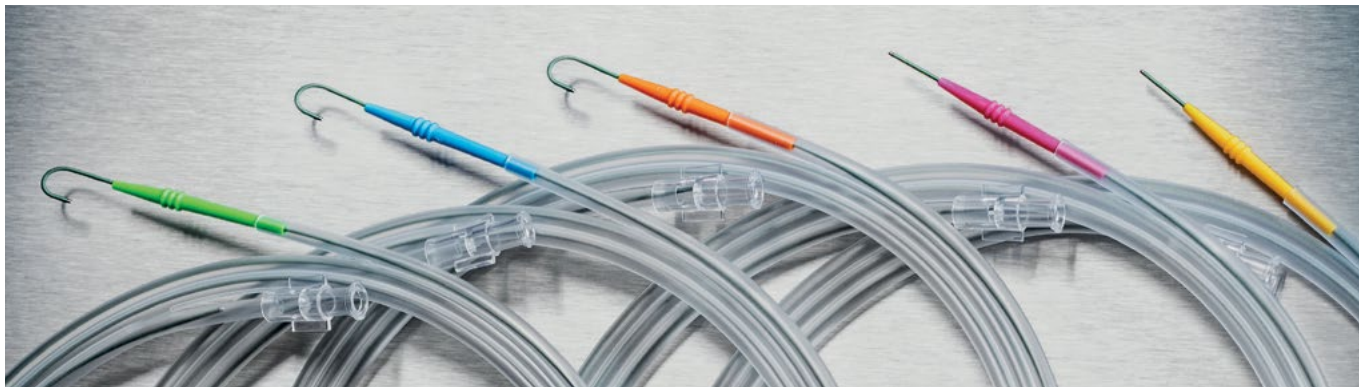

**Dimensions**

Ø 0.032" / 0,81 mm  
Ø 0.035" / 0,89 mm  
Ø 0.038" / 0,96 mm

**Length**

50 – 260 cm

**Surface**

Stainless steel  
PTFE coated

**Distal tip form**

Straight tip  
J-tip radius: 1,5 – 3 – 6 – 15 mm

**Shaft stiffness**

Standard  
Stiff

**Customised products on request**

**Description of item code**

(H)-M-(X)-S/Jx-(C)-0xx-L  
(example: M-S-C-035-150)

<b>M</b>	Movable Guide Wire
<b>H-M</b>	Stiff Movable Guide Wire
<b>S</b>	Straight tip
<b>Jx</b>	J-tip radius J1.5 mm J3 mm J6 mm J15 mm
<b>C</b>	PTFE coated
<b>Without C</b>	stainless steel
<b>0xx:</b>	Diameter of the guide wire <b>032:</b> 0.032" (0,81 mm) <b>035:</b> 0.035" (0,89 mm) <b>038:</b> 0.038" (0,96 mm)
<b>L:</b>	Length of the guide wire (from 30 – 450 cm)

Accoat™ Standard Guide Wire – Lunderquist PTC

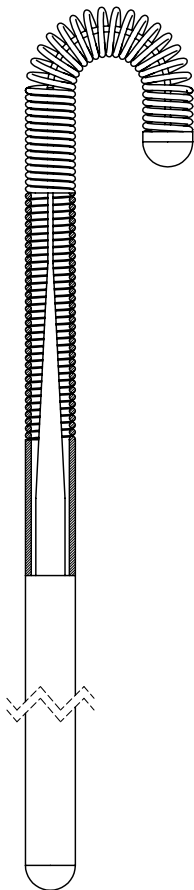
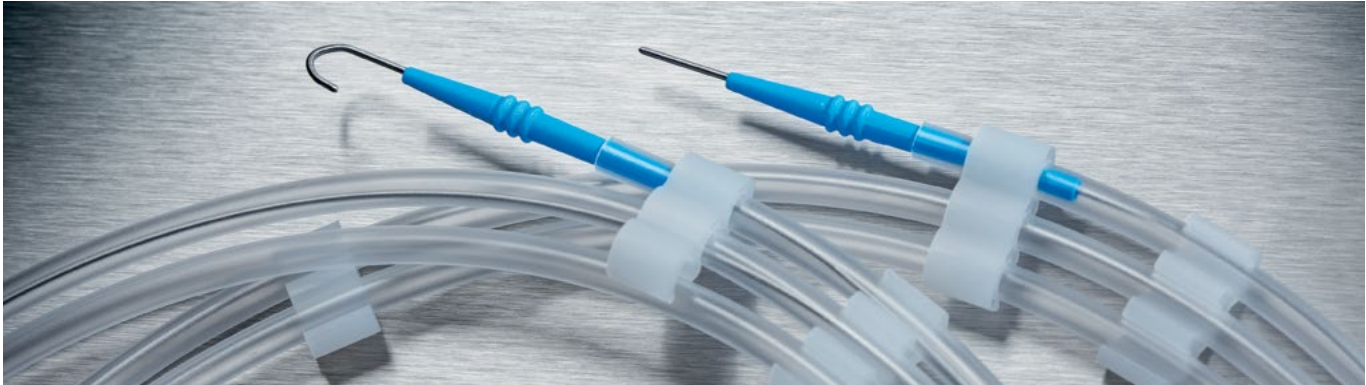

**Dimensions**

Ø 0.025" / 0,63 mm

Ø 0.035" / 0,89 mm

**Length**

- 50 cm
- 60 cm
- 70 cm
- 80 cm
- 90 cm
- 100 cm
- 120 cm
- 150 cm
- 260 cm

**Surface**

- Stainless steel
- PTFE coated

**Distal tip form**

- Straight tip
- J-tip radius: 1,5 – 3 – 6 mm

**Distal flexible length**

- 5 cm
- 7 cm
- 10 cm
- 12 cm
- 15 cm
- 17 cm

**Customised products on request**

**Description of item code**

PTC-S/Jx-C-Fx-0xx-L

(example: PTC-S-C-F5-035-150)

<b>S</b>	Straight tip
<b>Jx</b>	J-tip radius J1,5 mm tip J3 mm tip J6 mm tip
<b>C</b>	PTFE coated
<b>Without C</b>	stainless steel
<b>Fx</b>	Distal Flexible length F5 - 5 cm flexible tip F7 - 7 cm flexible tip F10 - 10 cm flexible tip F12 - 12 cm flexible tip F15 - 15 cm flexible tip F17 - 17 cm flexible tip
<b>0xx:</b>	Diameter of the guide wire <b>025:</b> 0.025" (0,63 mm) <b>035:</b> 0.035" (0,89 mm)
<b>L:</b>	Length of the guide wire 50, 60, 70, 80, 90, 100, 120, 150 and 260 cm

Accoat™ Standard Guide Wire – Schüller PTC

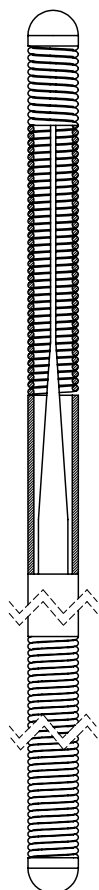
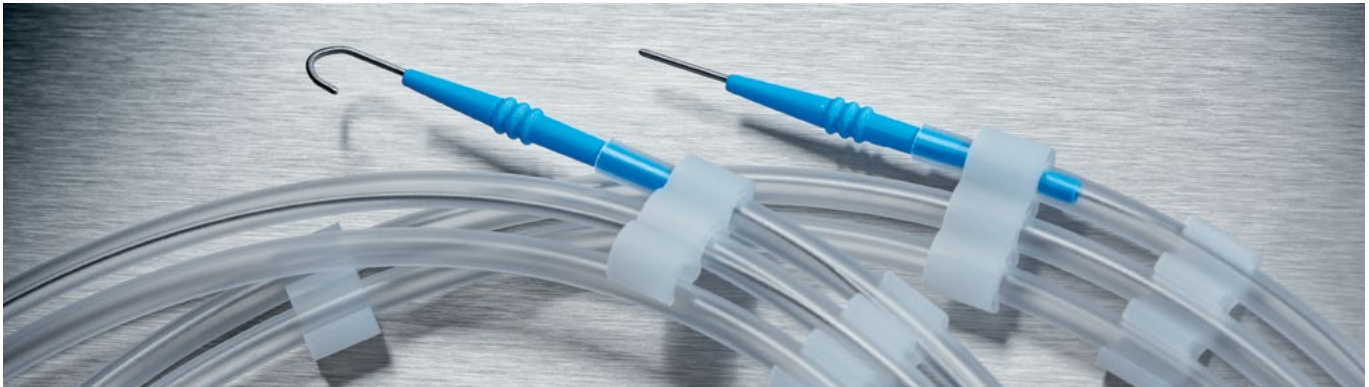

**Dimensions**

Ø 0.025" / 0,63 mm  
Ø 0.035" / 0,89 mm

**Length**

50 cm  
60 cm  
70 cm  
80 cm  
90 cm  
100 cm  
110 cm  
120 cm  
150 cm  
260 cm

**Surface**

Stainless steel  
PTFE coated

**Distal tip form**

Straight tip  
J-tip radius:  
1,5 – 3 – 6 mm

**Customised products on request**

**Distal flexible length**

5 cm  
7 cm  
10 cm  
12 cm  
15 cm  
17 cm

**Proximal flexible length**

30 cm  
33 cm  
35 cm  
38 cm  
40 cm  
43 cm  
45 cm  
50 cm  
53 cm  
55 cm  
60 cm  
63 cm  
65 cm

**Description of item code**

PTC-SCH-S/Jx-C-Fx-yy-zz-0xx-L  
(example: PTC-SCH-S-F5-40-55-035-100)

<b>S</b>	Straight tip
<b>Jx</b>	J-tip radius J1,5 mm tip J3 mm tip J6 mm tip
<b>C</b>	PTFE coated
<b>Without C</b>	stainless steel
<b>Fx</b>	Distal Flexible length x = cm ex. F5 = 5 cm Available in 5, 7, 10, 12, 15 or 17 cm
<b>yy</b>	Shaft length - cm
<b>zz</b>	Proximal Flexible length - cm Available in 30, 33, 35, 38, 40, 43, 45, 50, 53, 55, 60, 63 or 65 cm
<b>0xx:</b>	Diameter of the guide wire <b>025:</b> 0.025" (0,63 mm) <b>035:</b> 0.035" (0,89 mm)
<b>L:</b>	Length of the guide wire (Sum of Fx+yy+zz) Available in 50, 60, 70, 80, 90, 100, 110, 120, 150 or 260 cm



Poseidon™ Hydrophilic Nitinol Guide Wire

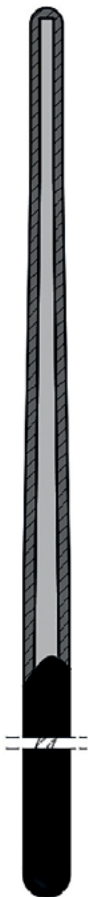
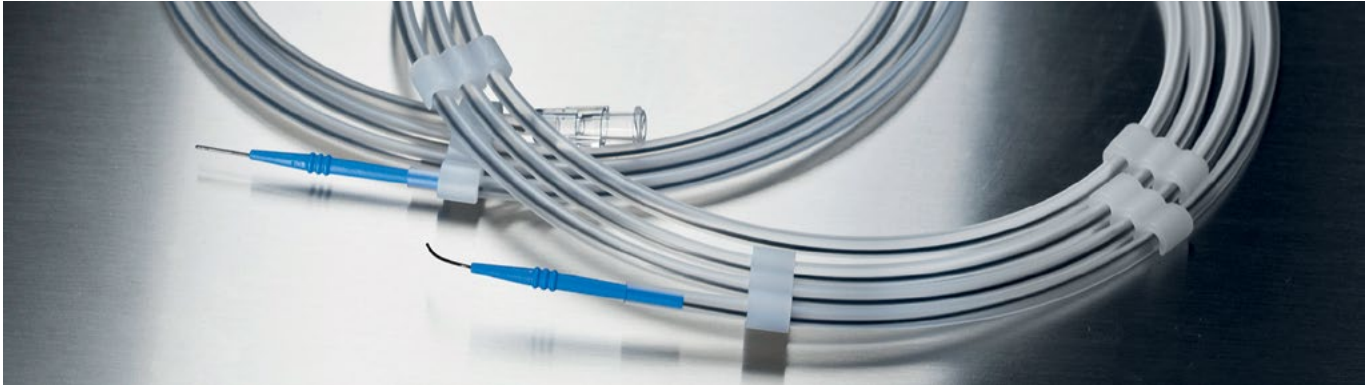

**Dimensions**

- Ø 0.018" / 0,46 mm
- Ø 0.025" / 0,63 mm
- Ø 0.032" / 0,81 mm
- Ø 0.035" / 0,89 mm
- Ø 0.038" / 0,96 mm

**Length**

30 – 260 cm

**Surface**

Hydrophilic coated - Black

**Distal tip form**

- Angled
- Straight
- Reshapable

**Shaft stiffness**

- Standard
- Stiff
- (Stiff not available in dim: 0.018")

**Tip stiffness**

- Standard
- Soft
- Floppy

**Speciality Guide Wire:**

**Double Ended Flexible Tip**

One end angled standard tip,  
other end straight soft tip.  
Stiff shaft stiffness.  
Available in 150 & 180 cm.

**Customised products on request**

**Description of item code**

Hy – N – S/R/A – ST/SO/F – 0xx – D/H – L  
(example: Hy-N-A-ST-035-D-150)

<b>DE</b>	Double ended
<b>HY</b>	Hydrophilic coating
<b>N</b>	Nitinol core
<b>S</b>	Straight tip
<b>A</b>	Angled tip
<b>R</b>	Reshapable tip
<b>ST</b>	Standard tip stiffness
<b>SO</b>	Soft tip stiffness
<b>F</b>	Floppy tip stiffness
<b>0xx</b>	Diameter of the guide wire <b>018:</b> 0.018" (0,46 mm) <b>025:</b> 0.025" (0,63 mm) <b>032:</b> 0.032" (0,81 mm) <b>035:</b> 0.035" (0,89 mm) <b>038:</b> 0.038" (0,96 mm)
<b>H</b>	Stiff shaft
<b>D</b>	Standard shaft
<b>L</b>	Length of the GW (from 30 – 260 cm)

**CHAMPION™ PTCA Guide Wire – For Cardiology use (CAR)**

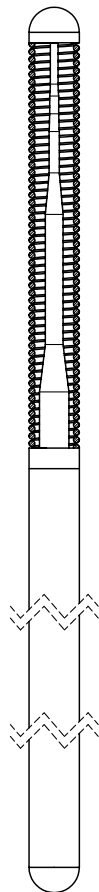
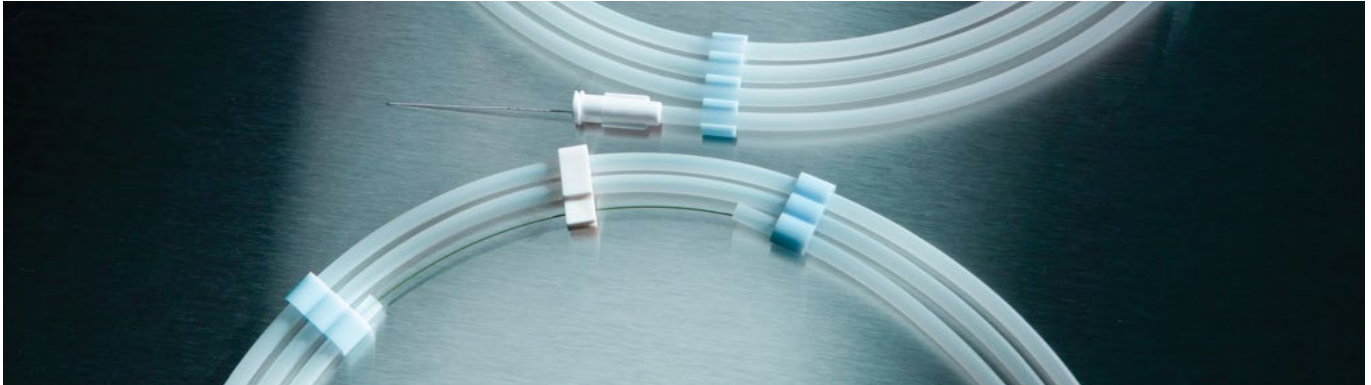

**Dimension**

Ø 0.014" / 0,36 mm

**Length**

175 cm  
195 cm  
300 cm

**Distal tip form**

Straight  
J-tip

**Stent zone stiffness**

Standard  
Stiff

**Tip stiffness**

Standard  
Intermediate  
Floppy  
Extra Floppy

**Radiopaque length**

3 cm

**Coil surface**

Uncoated – Stainless Steel  
Hydrophilic coated  
Silicone coated

**Shaft surface**

PTFE coated

**Description of item code**

PTCA-CAR-S/J-M/HY/SI-EF/F/I/ST-D/H-014-L  
(example: PTCA-CAR-S-HY-F-D-014-175)

<b>CAR</b>	For cardiology use
<b>S</b>	Straight tip
<b>J</b>	J-tip
<b>M</b>	Coil surface uncoated – stainless steel
<b>HY</b>	Coil surface hydrophilic
<b>SI</b>	Coil surface silicone
<b>EF</b>	Tip stiffness extra floppy
<b>F</b>	Tip stiffness floppy
<b>I</b>	Tip stiffness intermediate
<b>ST</b>	Tip stiffness standard
<b>D</b>	Stent zone stiffness standard
<b>H</b>	Stent zone stiffness stiff
<b>014:</b>	Diameter of the guide wire 0.014" (0,36 mm)
<b>L:</b>	Length of the guide wire Available in 175, 195, 300 cm

**CHAMPION™ PTCA Guide Wire – Stiff tip for highly stenosed lesions (CTO)**

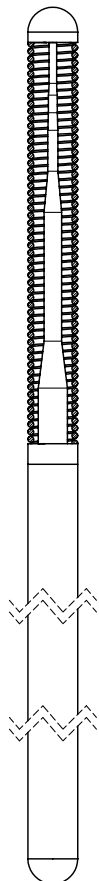
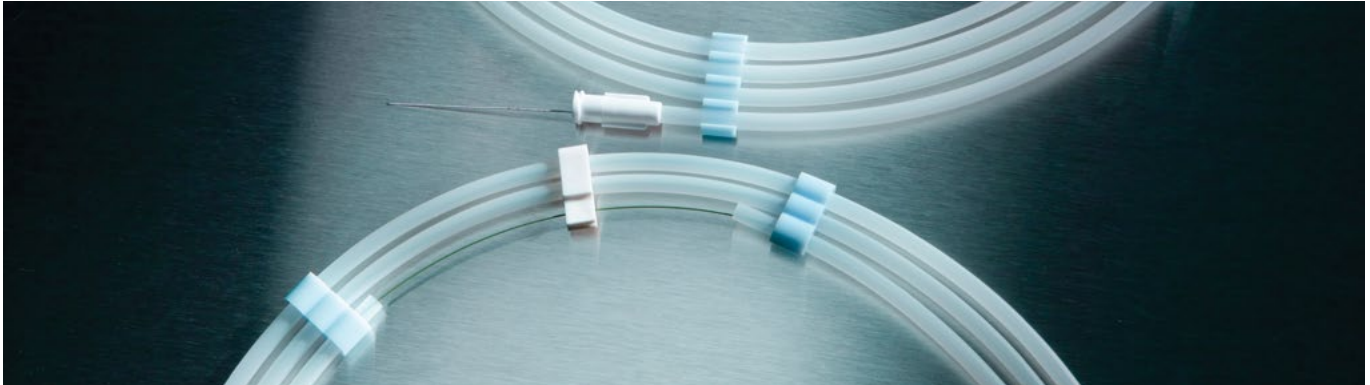

**Dimension**

Ø 0.014" / 0,36 mm

**Length**

195 cm  
300 cm

**Distal tip form**

Straight  
J-tip

**Stent zone stiffness**

Standard

**Tip stiffness (Gram Force)**

3,0gf  
4,5gf  
6,0gf  
9,0gf  
12,0gf

**Radiopaque length**

3 cm

**Coil surface**

Hydrophilic coated  
Silicone coated

**Shaft surface**

PTFE coated

**Description of item code**

PTCA-CTO-S/J-SI/HY-3/4,5/6/9/12-D-014-L  
(example: PTCA-CTO-S-HY-3-D-014-175)

<b>CTO</b>	For highly stenosed lesions
<b>S</b>	Straight tip
<b>J</b>	J-tip
<b>HY</b>	Coil surface hydrophilic
<b>SI</b>	Coil surface silicone
<b>3</b>	Tip stiffness 3 Gram Force
<b>4,5</b>	Tip stiffness 4,5 Gram Force
<b>6</b>	Tip stiffness 6 Gram Force
<b>9</b>	Tip stiffness 9 Gram Force
<b>12</b>	Tip stiffness 12 Gram Force
<b>D</b>	Stent zone stiffness standard
<b>014:</b>	Diameter of the guide wire 0.014" (0,36 mm)
<b>L:</b>	Length of the guide wire Available in 195, 300 cm

## Coating of Medical Devices and Components

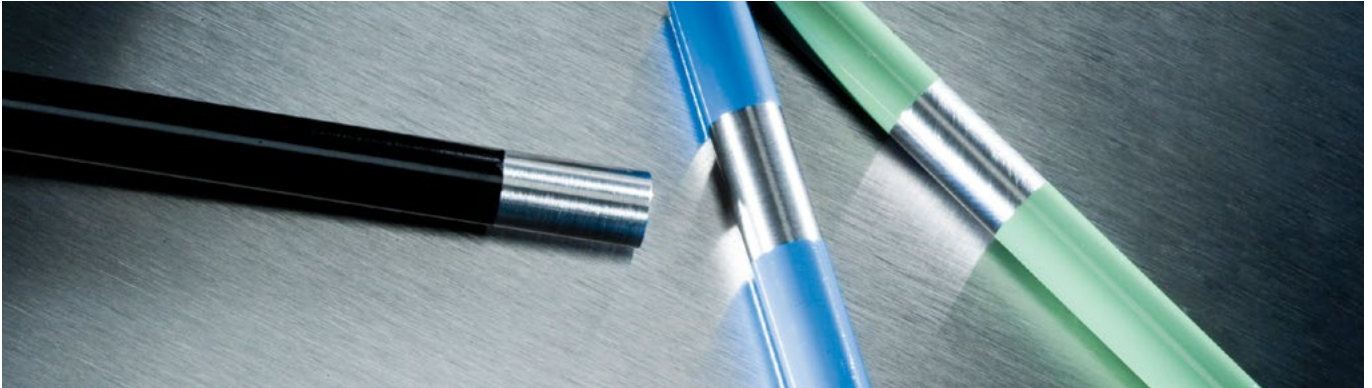

SP Medical has developed a wide range of hydrophobic and hydrophilic coatings for optimizing of different product features.

Typical features are: Low friction, electrical insulation, chemical resistance and markers.

The coatings are specially designed for devices and components as: Guide wires, needles, electrodes, tubes, coils, cores, displays etc.

Coatings can either be spray- or dip coated in the following colours:

- Blue
- Black
- Green
- Grey
- Transparent

A special feature as masking or partial coating is available.

**Customised products on request**

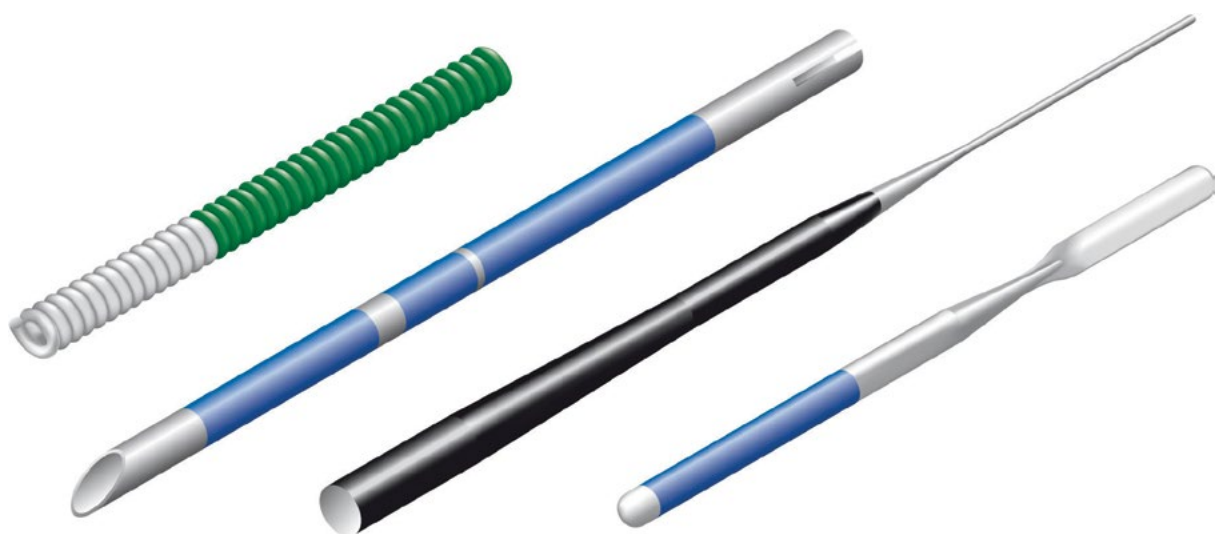

Accessories and packing material

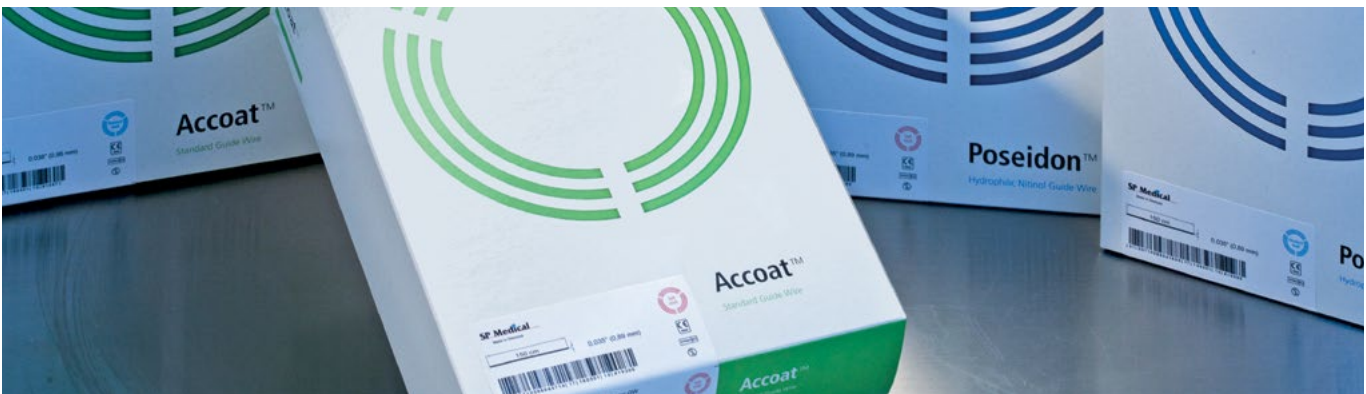

SP Medical has developed a very flexible programme of packing materials to supply optimal protection of Guide Wires and Catheters.

**Clipless Dispensers**

The new design – No Clip Penetration – ensures the highest level of sterility during transportation and storage.

- Suitable for Guide Wires from 40 – 200 cm
- Internal Dispenser diameter from 9 to 19 cm
- Standard tubing dimension is Ø 4,0 x 2,75 mm.
- Tubing material is PP

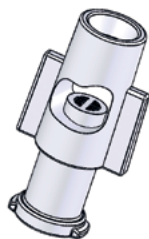

**Dispenser with clips**

- Suitable for Guide Wires of any length up to 450 cm
- Internal Dispenser diameter is 14,5 cm
- Standard tubing dimension is Ø 4,0 x 2,75 mm
- Tubing material is PP or PE

**Customised products on request**

- Variable Dispenser shape
- Variable Dispenser diameter
- Variable tubing dimensions
- Variable tubing material and colour

**Available packing components**

- J-Straightner in different colours
- Female Luerlock with protection grid
- 2, 3 and 4 cavity clips
- Peel pouches
- Tip protector

## Quality and Regulatory Affairs

### Quality and Regulatory

SP Medical's management system takes into account all the demands on and expectations faced by providers to the global medical device industry:

- We are certified to the ISO 9001, ISO 13485 and ISO 14001 standards.
- We have CE mark certification under the Medical Device Directive 93/42/EEC as amended by 2007/47/EEC.
- We comply with the Global Harmonization Task Force Guidelines.
- We build and maintain our cleanroom environments in accordance with ISO 14644 and ISO 14698.

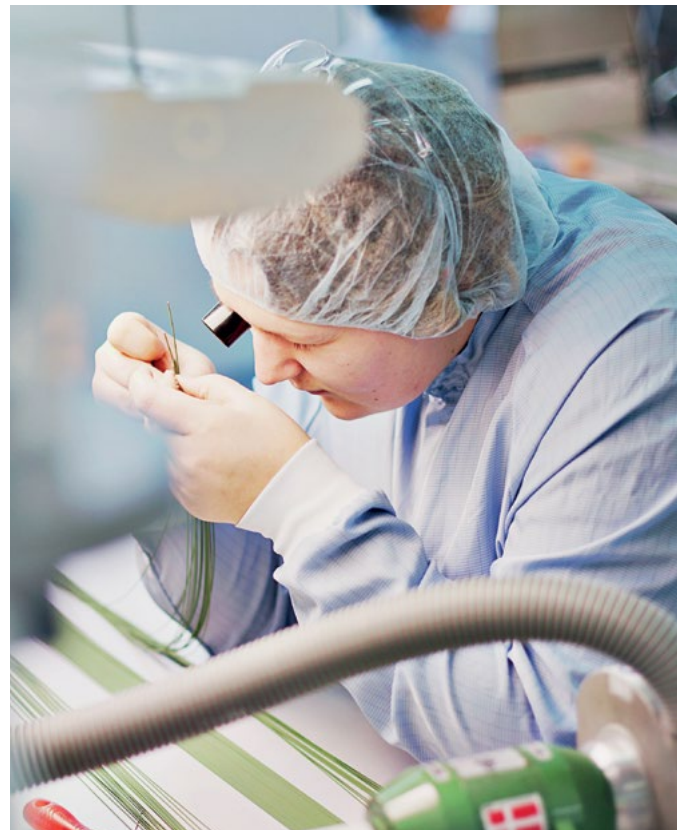



---

**SP Medical A/S**

Møllevej 1

DK-4653 Karise

Denmark

Tel.: (+45) 5676-6000

Fax: (+45) 5676-6001

E-mail: [gw@sp-medical.com](mailto:gw@sp-medical.com)

[www.sp-medical.com](http://www.sp-medical.com)

---